

# Data Sheet



Article number: 582S20020EG

Description: Fluid control valve - 2/2 NC, 2S20020EG - 24VAC  
port 3/4" - orifice 20 internally piloted, stainless steel

## Measures

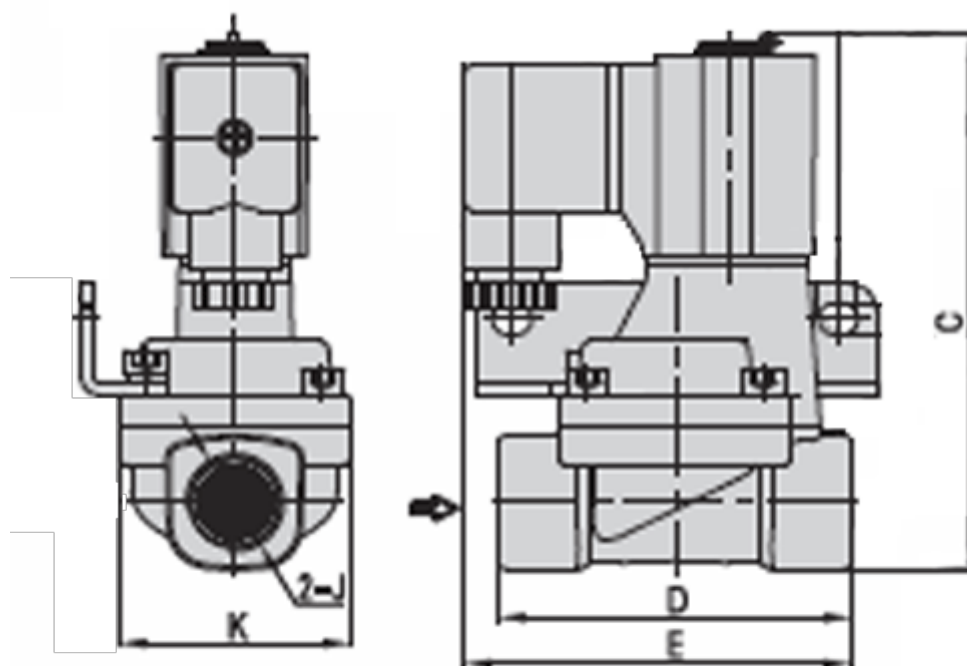

C = 115.4

D = 82

E = 78.5

J = G 3/4"

K = 53